

Einbauanleitung	Instrucciones de instalación	Installationsanvisningar
Installation Instructions	Instruções de instalação	Instrukcja instalacji
Instructions d'installation	Installatie-instructies	Kurulum Talimatları
Istruzioni per l'installazione	Pokyny pro instalaci	Инструкции по установке

## USB, Digimatic, U-WAVE®

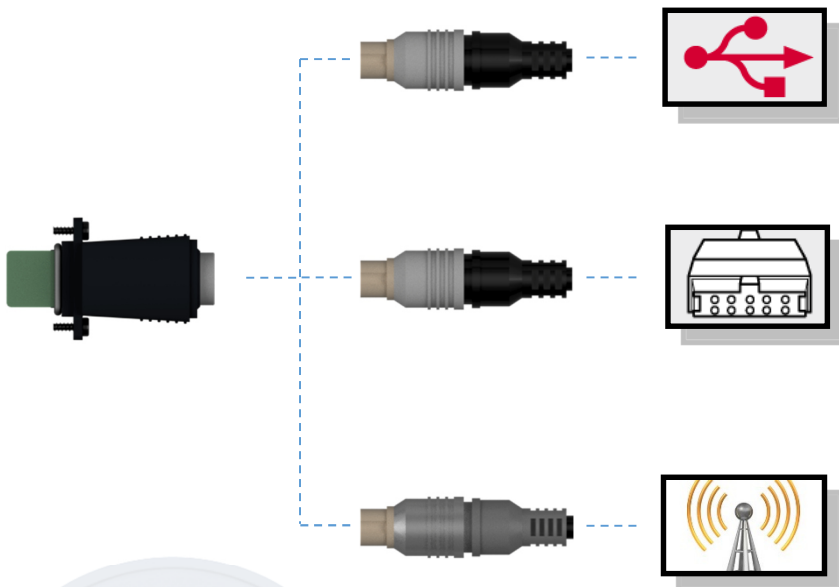

**C- / G- / K- / L- Serie**

**Kroeplin**  
Längenmesstechnik

**Inhaltsverzeichnis / Table of contents / Table des matières /  
Sommario / Tabla de contenido / Inhoudsopgave / Índice / Obrázek /  
Innehållsförteckning / Spis treści / İçindekiler / Содержание**

Einbau / Installation / Installation / Installazione / Instalación / Instalação / Installatie / Instalace / Installation / Instalacja / Kurulum / Инструкции по установке	3
Deutsch	4
English	5
Français	6
Italiano	7
Español	8
Português	9
Nederlands	10
Czeski	11
Svenska	12
Polski	13
Türk	14
Русский	15

Einbau / Installation / Installation / Installazione / Instalación /  
Instalação / Installatie / Instalace / Installation / Instalacja /  
Kurulum / Инструкции по установке

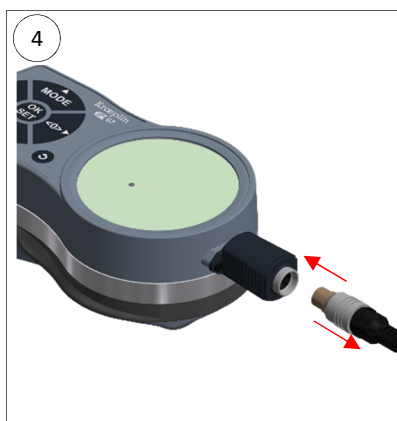
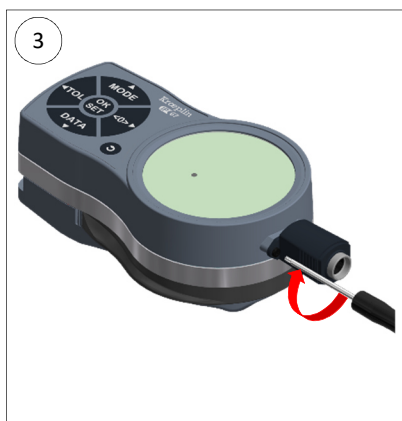
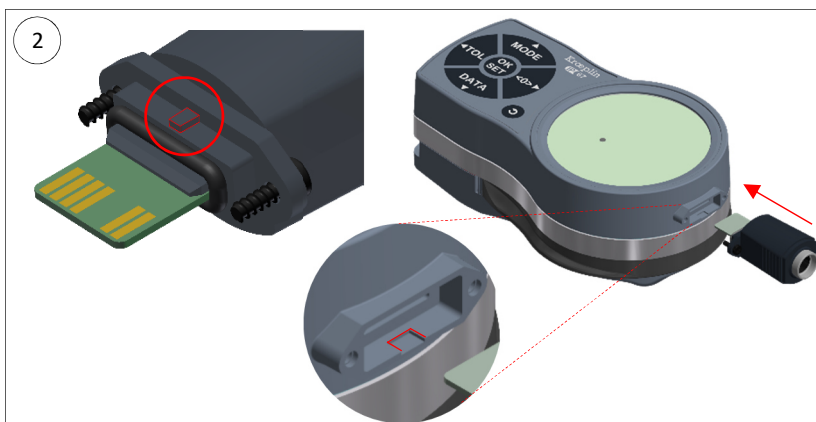
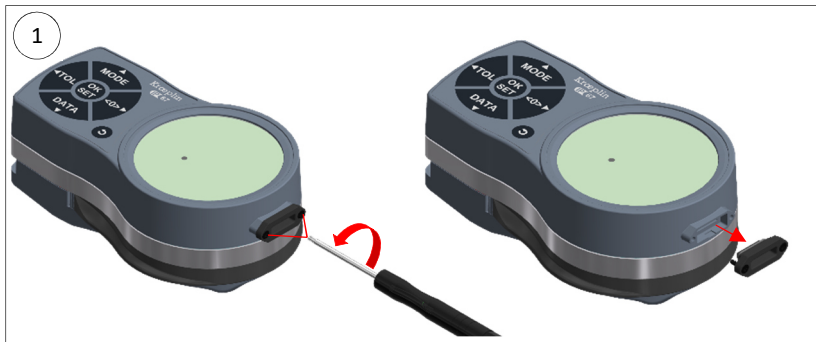

### Lieferumfang

- Schnittstellenadapter (1961-09)
- Schraubendreher (1602-28)
- Einbauanleitung Schnittstelle (0689-33)

### Kompatibilität

- Datenkabel USB (2482-05), Digimatic (2482-07) oder U-WAVE® (2482-04)

Die Schnittstelle Digimatic ist kompatibel zu Mitutoyo Auswertgeräten.

U-WAVE® Spezifikationen siehe Angaben von Mitutoyo.

**(U-WAVE® Sender und Empfänger sind separat erhältlich siehe unten)**

### Schnittstellen

Die Schnittstellen sind als Zubehör erhältlich und können jederzeit nachgerüstet werden. Sie bestehen jeweils aus einem Adapter und dem entsprechenden Datenkabel.

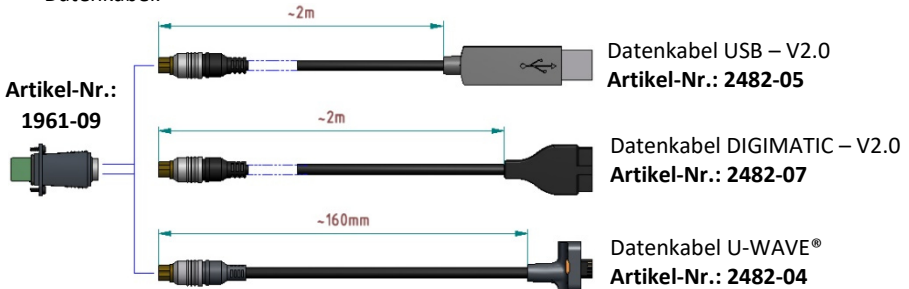

**Fehlermeldungen siehe Bedienungsanleitung des Gerätes!**

### U-WAVE® - Zubehör



**Scope of Delivery**

- Interface adapter (1961-09)
- Screwdriver (1602-28)
- Interface installation instructions (0689-33)

**Compatibility**

- Data cable USB (2482-05), Digimatic (2482-07), or U-WAVE® (2482-04)

The Digimatic interface is compatible with Mitutoyo signal conditioning instruments.

Consult information provided by Mitutoyo for or U-WAVE® specifications.

**(U-WAVE® transmitter and receiver are available separately, see below)**

**Interfaces**

The interfaces are available as accessories and can be retrofitted at any time. They each consist of an adapter and the corresponding data cable.

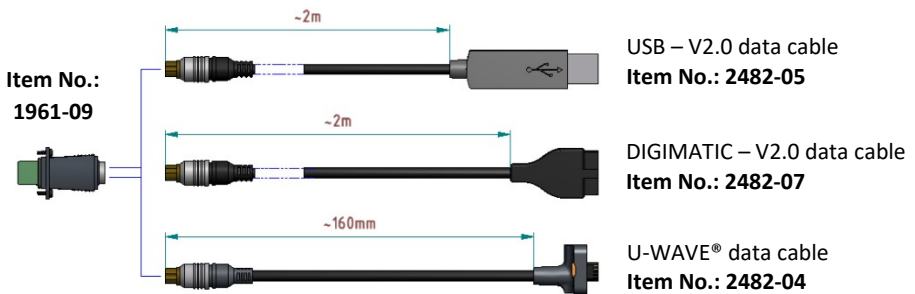

**For error messages, see the operating instructions for the device!**

**U-WAVE® accessories**



### Contenu de la livraison

- Adaptateur d'interface (1961-09)
- Tournevis (1602-28)
- Instructions d'installation de l'interface (0689-33)

### Compatibilité

- Câble de données USB (2482-05), Digimatic (2482-07) ou U-WAVE® (2482-04)

L'interface Digimatic est compatible avec les instruments de conditionnement de signal Mitutoyo.

Consultez les informations fournies par Mitutoyo pour les spécifications U-WAVE®.

**(L'émetteur et le récepteur U-WAVE® sont disponibles séparément, voir ci-dessous)**

### Interfaces

Les interfaces sont disponibles sous forme d'accessoires et peuvent être adaptées à tout moment. Elles se composent chacune d'un adaptateur et du câble de données correspondant.

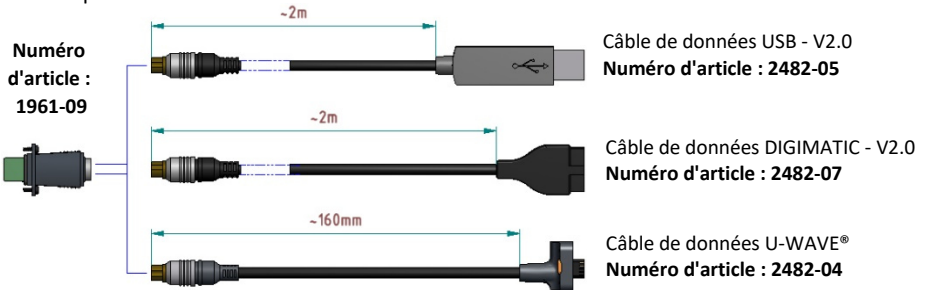

**Pour les messages d'erreur, consultez le mode d'emploi de l'appareil !**

### Accessoires U-WAVE®



### Contenuto della confezione

- Adattatore di interfaccia (1961-09)
- Cacciavite (1602-28)
- Istruzioni per l'installazione dell'interfaccia (0689-33)

### Compatibilità

- Cavo dati USB (2482-05), Digimatic (2482-07) o U-WAVE® (2482-04)

L'interfaccia Digimatic è compatibile con gli strumenti Mitutoyo per il condizionamento del segnale.

Consultare le informazioni fornite da Mitutoyo o le specifiche U-WAVE®.

**(Il trasmettitore e il ricevitore U-WAVE® sono disponibili separatamente, vedere di seguito)**

### Interfacce

Le interfacce sono disponibili come accessori e possono essere aggiornate in qualsiasi momento. Ognuna di esse è costituita da un adattatore e dal cavo dati corrispondente.

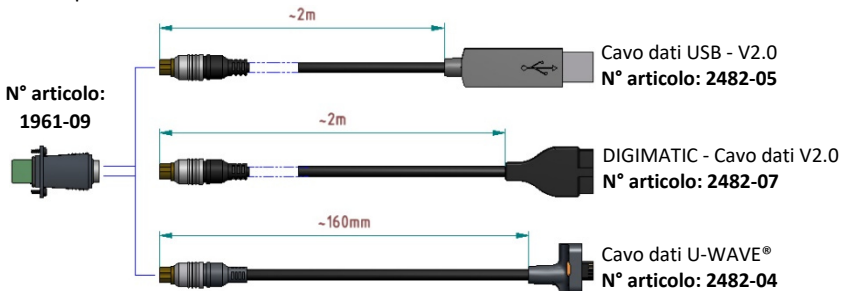

**In caso di messaggi di errore, vedere le istruzioni per l'uso del dispositivo.**

### Accessori U-WAVE®

Trasmettitore U-WAVE®-T  
(Modello IP67)  
N° articolo: 2482-01

Ricevitore U-WAVE®-R  
N° articolo: 2482-02



## Alcance de suministro

- Adaptador de interfaz (1961-09)
- Destornillador (1602-28)
- Instrucciones de instalación de interfaz (0689-33)

## Compatibilidad

- Cable de datos USB (2482-05), Digimatic (2482-07) o U-WAVE® (2482-04)

La interfaz Digimatic es compatible con los instrumentos acondicionadores de señal Mitutoyo.

Consulte la información proporcionada por Mitutoyo para conocer las especificaciones de U-WAVE®.

**(El transmisor y receptor U-WAVE® están disponibles por separado, ver más abajo)**

## Interfaces

Las interfaces están disponibles como accesorios y se pueden adaptar en cualquier momento. Cada una de ellas contiene un adaptador y el cable de datos correspondiente.

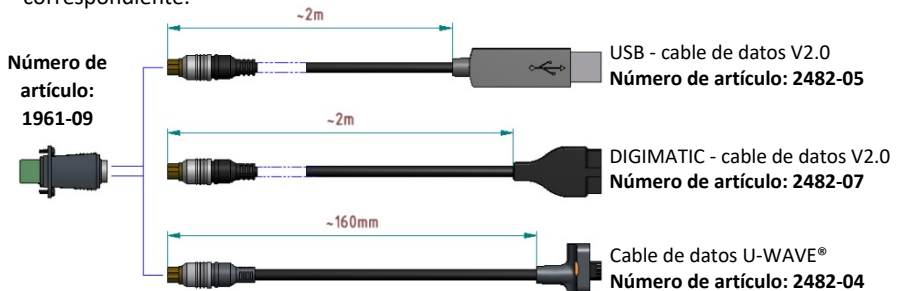

Para tratar mensajes de error, consulte las instrucciones de uso del dispositivo.

## Accesorios U-WAVE®

Transmisor U-WAVE®-T  
(Modelo IP67)  
Número de artículo: 2482-01

Receptor U-WAVE®-R  
Número de artículo: 2482-02





### Âmbito da entrega

- Adaptador do interface (1961-09)
- Chave de fendas (1602-28)
- Instruções de instalação do interface (0689-33)

### Compatibilidade

- Cabo de dados USB (2482-05), Digimatic (2482-07) ou U-WAVE® (2482-04)

O interface Digimatic é compatível com os instrumentos de condicionamento do sinal Mitutoyo.

Consulte a informação fornecida pela Mitutoyo para obter as especificações do U-WAVE®.

**(O transmissor e o recetor U-WAVE® encontra-se disponível separadamente, ver abaixo)**

### Interfaces

Os interfaces encontram-se disponíveis como acessórios e podem ser adaptados a qualquer momento. Cada um é constituído por um adaptador e pelo cabo de dados correspondente.

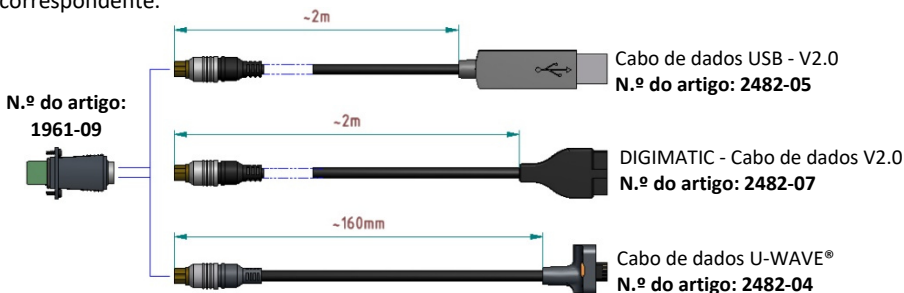

**Para mensagens de erro, consulte o manual de instruções do dispositivo!**

### Acessórios U-WAVE®

Transmissor U-WAVE®-T  
(Modelo IP67)  
N.º do artigo: 2482-01

Recetor U-WAVE®-R  
N.º do artigo: 2482-02



## Leveringsomvang

- Interface-adapter (1961-09)
- Schroevendraaier (1602-28)
- Installatie-instructies voor interface (0689-33)

## Compatibiliteit

- Datakabel USB (2482-05), Digimatic (2482-07) of U-WAVE® (2482-04)

De Digimatic-interface is compatibel met signaalconditioneringsinstrumenten van Mitutoyo.

Raadpleeg de informatie verstrekt door Mitutoyo voor onze U-WAVE® specificaties.

**(U-WAVE® zender en ontvanger zijn apart verkrijgbaar, zie hieronder)**

## Interfaces

De interfaces zijn beschikbaar als accessoires en kunnen op elk moment worden gewijzigd. Ze bestaan elk uit een adapter en de bijbehorende datakabel.

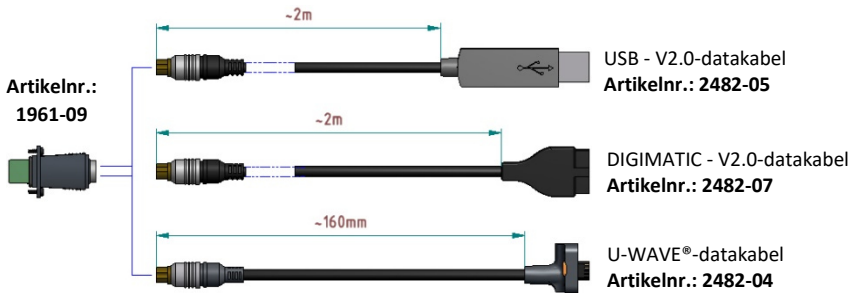

**Raadpleeg de bedieningshandleiding van het apparaat voor foutmeldingen!**

## U-WAVE®-accessoires



### Rozsah dodávky

- Adaptér rozhraní (1961-09)
- Šroubovák (1602-28)
- Pokyny pro instalaci rozhraní (0689-33)

### Kompatibilita

- Datový kabel USB (2482-05), Digimatic (2482-07) nebo U-WAVE® (2482-04)

Rozhraní Digimatic je kompatibilní s přístroji Mitutoyo pro úpravu signálu.

Technické údaje U-WAVE® naleznete v informacích od společnosti Mitutoyo.

**(Vysílač a přijímač U-WAVE® jsou k dispozici samostatně, viz níže)**

### Rozhraní

Rozhraní jsou k dispozici jako příslušenství a lze je kdykoli dovybavit. Každé se skládá z adaptéru a odpovídajícího datového kabelu.

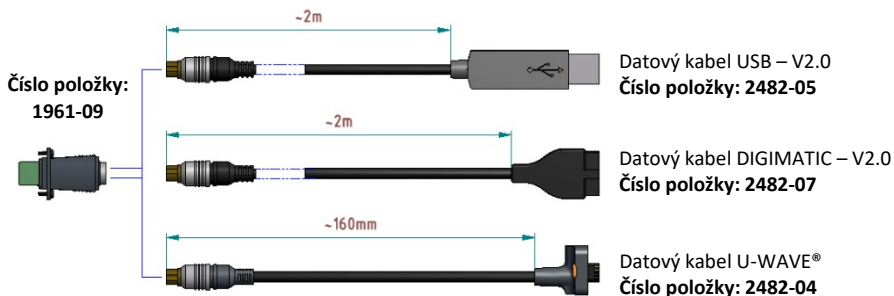

**Chybová hlášení naleznete v návodu k obsluze zařízení!**

### Příslušenství U-WAVE®



### Leveransens omfattning

- Gränssnittsadapter (1961-09)
- Skruvmejsel (1602-28)
- Installationsinstruktioner för gränssnitt (0689-33)

### Kompatibilitet

- Datakabel USB (2482-05), Digimatic (2482-07) eller U-WAVE® (2482-04)

Digimatic-gränssnittet är kompatibelt med Mitutoyo signalomvandlingsinstrument.

Se information som tillhandahålls av Mitutoyo för specifikationer om U-WAVE®.

**(Sändare och mottagare för U-WAVE® finns tillgängliga separat, se nedan)**

### Gränssnitt

Gränssnitten finns som tillbehör och kan monteras i efterhand när som helst. De består alla av en adapter samt motsvarande datakabel.

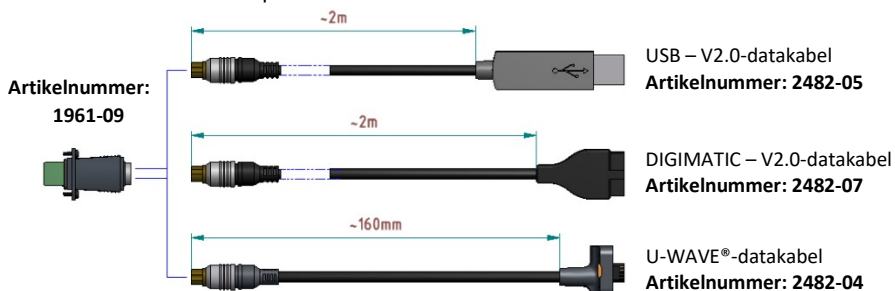

Se enhetens bruksanvisning för information om felmeddelanden!

### Tillbehör för U-WAVE®



### Zakres dostawy

- Adapter interfejsu (1961-09)
- Śrubokręt (1602-28)
- Instrukcja instalacji interfejsu (0689-33)

### Zgodność

- Kabel danych USB (2482-05), Digimatic (2482-07) lub U-WAVE® (2482-04)

Interfejs Digimatic jest kompatybilny z urządzeniami Mitutoyo do kondycjonowania sygnałów.

Zapoznaj się z informacjami przekazanymi przez Mitutoyo lub specyfikacjami U-WAVE®.

**(Nadajnik i odbiornik U-WAVE® są dostępne osobno, patrz poniżej)**

### Interfejsy

Interfejsy są dostępne jako akcesoria i mogą być w każdej chwili zmodernizowane. Każdy z nich składa się z adaptera i odpowiedniego kabla danych.

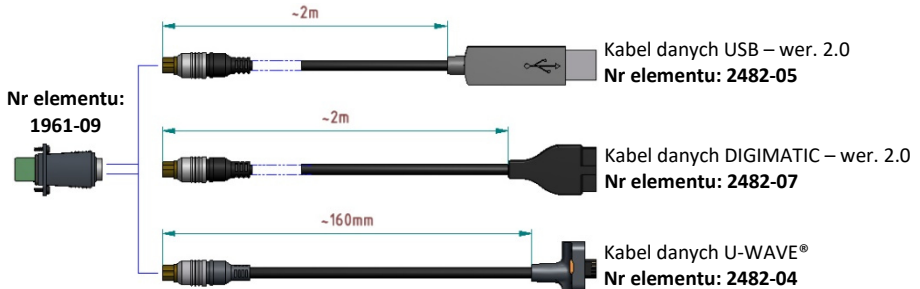

**Komunikaty o błędach znajdują się w instrukcji obsługi urządzenia!**

### Akcesoria U-WAVE®



### Teslimat Kapsamı

- Arayüz adaptörü (1961-09)
- Tornavida (1602-28)
- Arayüz kurulum talimatları (0689-33)

### Uygunluk

- Veri kablosu USB (2482-05), Digimatic (2482-07) veya U-WAVE® (2482-04)

Digimatic arayüzü, Mitutoyo sinyal koşullandırma cihazları ile uyumludur. U-WAVE® teknik özellikleri için Mitutoyo tarafından sağlanan bilgilere başvurun.

**(U-WAVE® verici ve alıcı ayrı olarak satılır, aşağıya bakın)**

### Arayüzler

Arayüzler aksesuar olarak mevcuttur ve istenildiğinde uyarlanabilir. Her biri bir adaptör ve ona uyum veri kablosundan oluşur.

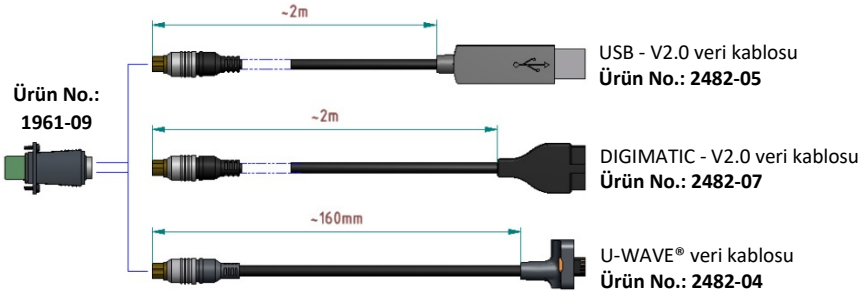

**Hata mesajları için, cihazın işletme talimatlarına bakınız!**

### U-WAVE® aksesuarları



## Комплект поставки

- Адаптер интерфейса (1961-09)
- Отвертка (1602-28)
- Инструкция по установке интерфейса (0689-33)

## Совместимость

- Кабель передачи данных USB (2482-05), Digimatic (2482-07) или U-WAVE® (2482-04)

Интерфейс Digimatic совместим с инструментами формирования сигнала Mitutoyo. См. информацию, предоставленную компанией Mitutoyo в отношении спецификаций U-WAVE®.

**(Передатчик и приемник U-WAVE® приобретаются отдельно, см. ниже)**

## Интерфейсы

Интерфейсы приобретаются дополнительно и могут быть модернизированы в любое время. Каждый из них состоит из адаптера и соответствующего кабеля передачи данных.

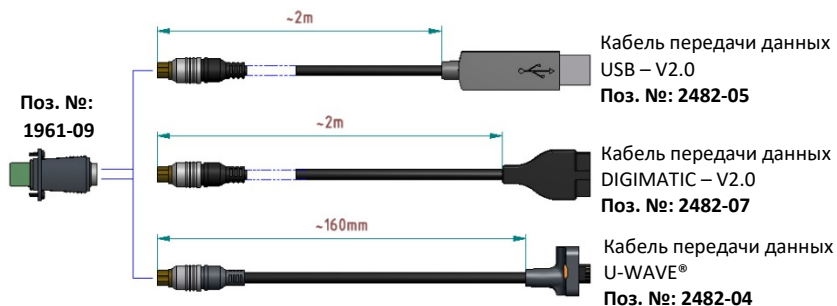

**Сообщения об ошибках см. в инструкции по эксплуатации устройства!**

## Аксессуары U-WAVE®



## Disposal:

**Disposal of waste electrical and electronic equipment (applies to countries of the European Union and other European countries with waste separation systems)**



This symbol on the product or its packaging indicates that this product must not be disposed of with normal household waste. To reduce the environmental impact of waste electrical and electronic equipment (WEEE) (Directive 2002/96/EC of the European Parliament and of the Council) and to minimise the amount of electronic waste disposed of in landfills, please reuse this product or recycle it. Contact your local distributor for more information.



## Note:

Kroeplin will not assume any liability towards any party for loss or damage, directly or indirectly, that is caused by using this device contrary to the instructions in this manual. All information about our products, particularly the illustrations, drawings, dimensions, and performance data and other technical information included in this publication, are approximate average values. We therefore reserve the right to modify the design, technical data, dimensions, and weight. Our indicated standards, similar technical regulations, and technical information, descriptions, and illustrations of the products are current as of the date of printing. The illustrations do not match the standard product in some instances. In addition, our general terms and conditions apply in their current version.

© Copyright Kroeplin GmbH. All rights reserved.

0689-33 (as of March 2020)

Kroeplin GmbH  
Gartenstraße 50  
36381 Schlüchtern  
T +49 (0)6661-86-0  
F +49 (0)6661-86-39  
sales@kroeplin.com  
www.kroeplin.com

**Kroeplin**  
Längenmesstechnik